



Most Trusted Traveling Irrigation Systems
Since 1964

Kifco Model B140 Water-Reel®



- Bellows Driven Water-Reel® with 1.4" ID x 350' MDPE Tube
- Simple, reliable, portable irrigation for sports fields, residential settings, hobby farms and food plots
- Automatic shutoff allows for unattended operation
- Mechanical levelwind system with miswrap safety for uniform, reliable tube rewinding
- Rugged construction proven by over 40 years of production and over 35,000 Kifco Water-Reels® sold
- Industry leading products with service and distribution at over 200 authorized dealers

Applicable Markets



Sports Fields



Residential Landscape,
Gardens & Nurseries



Hobby Farms, Food Plots and
Pastures

Standard Features and Benefits

- The Kifco Model B140 uses a water powered bellows drive which operates as low as 47 psi and 18 gpm with no additional pressure requirements making it more reliable than small turbines
- Retraction speed control dial provides easy adjustment and setting of application rate
- Sprinkler selector valve easily allows for automatic sprinkler shutoff at the end of the run or continued operation
- Three large flotation tires make transport by hand or small garden tractor simple

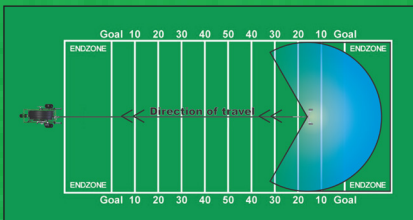

Easy Operation



Local Parts & Service

1 Year
Manufacturer's Warranty
5 Year
Pro Rated Tube Warranty



Engineered in the USA

www.kifco.com



700 S. Schrader Ave.
P.O. Box 290
Havana, IL 62644
800-452-7017 Toll Free
309-543-4425 Phone
309-543-4945 Fax

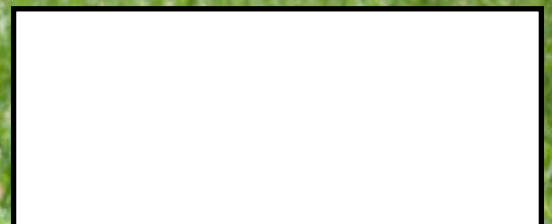

B140 Dimensions - B3 Chassis

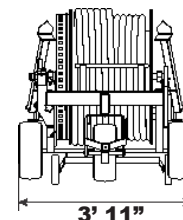
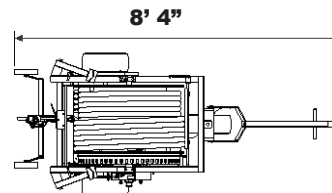
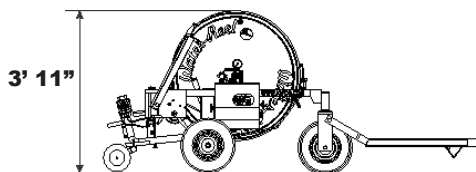
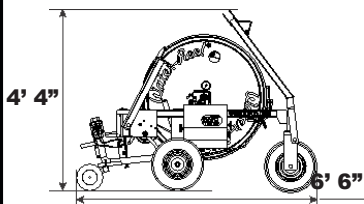

Sprinkler Diagram

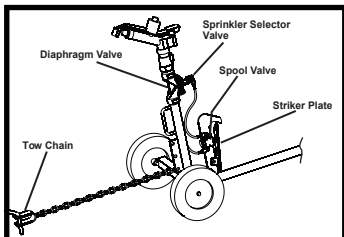

Mechanical Levelwind System

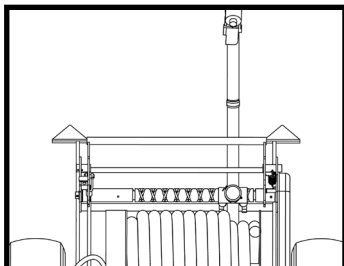

Technical Specifications

Tube Inner Diameter/Length	1.4" x 350'
Irrigated Width	100' - 198'
Irrigated Length	400' - 449'
Irrigated Area Per Run (Acres)	0.9 - 2.0
Drive System	Bellows
GPM Range	18 - 80
Inlet PSI Range	47 - 149
Hours Per Full Run	3.7 - 10
Retraction Speed	20 - 85 ft. per hour
Dry Weight	530 lbs.
Weight With Water	775 lbs.
Inlet Diameter	1.5" Male Camlock
Supply Hose	15' 1.5" Male x Female Camlock

Options

Booster Pumps	5.5Hp Gas, 9Hp Gas
Primary Pump	5.5Hp Gas, 9Hp Gas
Guncart Tire Upgrade	Added stability in rough terrain

Standard Connection

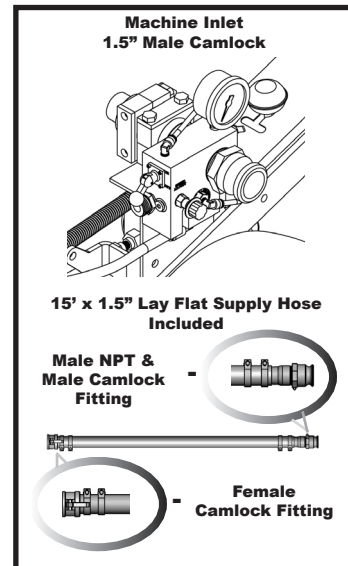

Sprinkler Performance

Sprinkler Model	Nozzle Dia.	Inlet PSI	(Q) GPM	Width (ft.) (80%)	Length (ft.) (80%)	Wetted Dia. (ft.)	Application Rate (in.)
Sime Hidra	10mm	58	28	110	405	137	.29 - 1.23
	10mm	77	33	118	409	148	.32 - 1.34
	12mm	56	40	105	402	131	0.43 - 1.84
	12mm	110	56	142	421	177	0.45 - 1.90
	14mm	73	52	110	405	138	0.53 - 2.27
	14mm	142	73	152	426	190	0.54 - 2.31
	16mm	96	65	115	408	144	0.64 - 2.72
	16mm	142	80	137	418	171	0.66 - 2.82

Sprinkler Model	Nozzle Dia.	Inlet PSI	(Q) GPM	Width (ft.) (80%)	Length (ft.) (80%)	Wetted Dia. (ft.)	Application Rate (in.)
Sime K1	8mm	50	18	100	400	125	.20 - .87
	8mm	66	21	108	404	135	.22 - .94
	10mm	58	28	108	404	135	.30 - 1.26
	10mm	77	33	115	408	144	.32 - 1.37
	12mm	48	33	100	400	125	.37 - 1.59
	12mm	96	47	123	412	154	.43 - 1.85

Sprinkler Model	Nozzle Dia.	Inlet PSI	(Q) GPM	Width (ft.) (80%)	Length (ft.) (80%)	Wetted Dia. (ft.)	Application Rate (in.)
Nelson SR75	.4"	53	27	119	410	149	0.2 - 0.6
	.4"	106	39	146	423	182	0.2 - 0.7
	.45"	53	32	123	412	154	0.3 - 0.7
	.45"	120	49	166	433	207	0.3 - 0.8
	.5"	62	40	131	416	164	0.3 - 0.8
	.5"	139	61	178	439	222	0.3 - 0.9
	.55"	75	49	138	419	172	0.4 - 1.0
	.55"	145	69	177	438	221	0.4 - 1.0

Sprinkler Model	Nozzle Dia.	Inlet PSI	(Q) GPM	Width (ft.) (80%)	Length (ft.) (80%)	Wetted Dia. (ft.)	Application Rate (in.)
Komet Twin Max	.39"	47	26	125	412	156	.24 - 1.00
	.39"	147	47	194	447	243	.27 - 1.16
	.43"	45	29	125	412	156	.26 - 1.12
	.43"	147	54	197	448	246	.31 - 1.30
	.47"	51	35	130	415	162	.31 - 1.30
	.47"	149	61	198	449	248	.35 - 1.48
	.51"	49	37	125	412	156	.34 - 1.43
	.51"	133	63	188	444	235	.38 - 1.61
	.55"	56	43	130	415	163	.37 - 1.59
	.55"	142	70	189	444	236	.42 - 1.79

Area covered may vary depending on wind conditions and use of different sprinklers. Specifications are subject to change without notice. Technical specifications contained herein are based upon sprinkler manufacturer's recommended pressure and flow. Actual specifications may vary. Bellows Flow approx. .48 to 1.31 gpm.