

Sprinkler Systems Design Guide

**Automated
Watering
Systems
for Greenhouse
and Nursery**



SpinNet Sprinkler



Why Netafim Systems Are Better

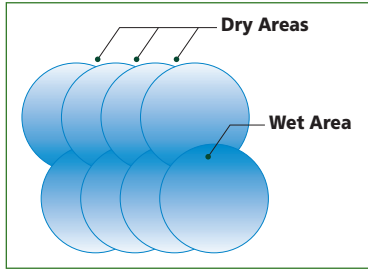

Traditional "Head to Head" Overlap.

Traditional sprinkler layout spaces the sprinklers "head to head" or at a spacing equal to the radius of the sprinkler throw. For larger areas, the patterns are overlapped creating both wet and dry areas.

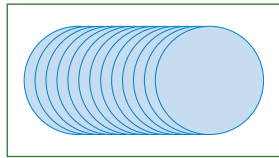

Netafim One Line Solution.

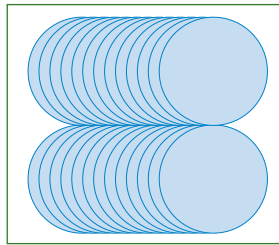

Netafim Two Line Solution.

The Netafim solution avoids the problems of the traditional sprinkler layout and achieves a high level of uniformity within a closely spaced "strip of sprinklers". By designing with these "strips" laid out side-by-side, large areas can be covered uniformly.

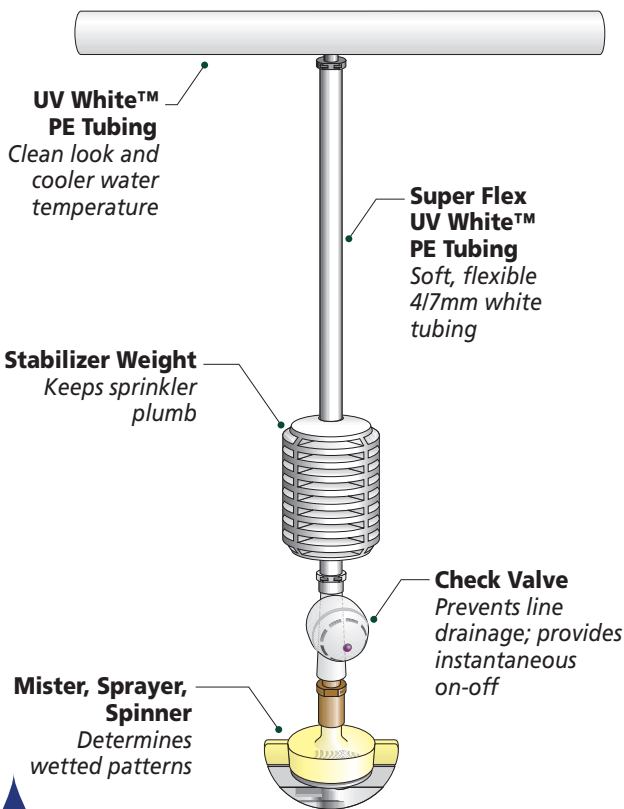
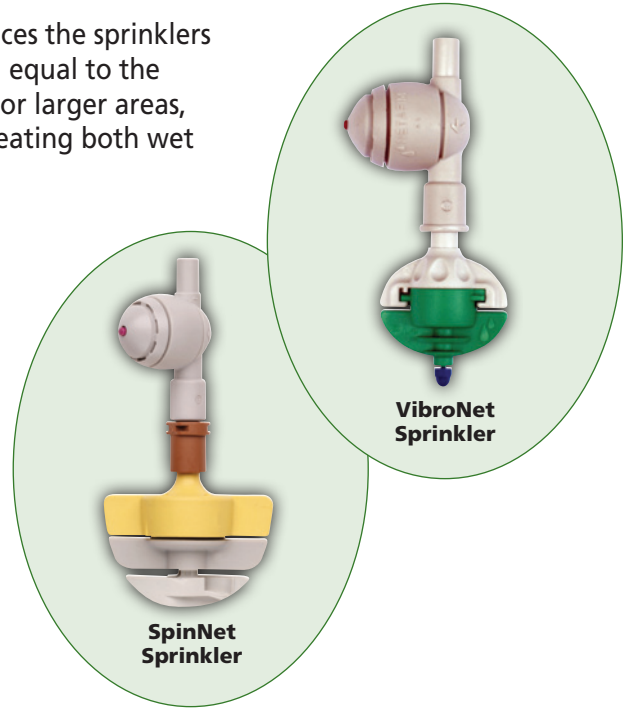

Low Cost and Fast Payback

- Payback for a complete system is usually within the first season of operation.

Drip-less Sprinklers

- The new SpinNet Sprinkler offers drip-less operation - the plants below are not damaged from water dripping off the sprinkler.
- Check Valve prevents the sprinkler line from draining onto the plants below after shut-down and provides instantaneous on-off for accurate short cycle watering and misting.
- Sprinklers hang below the supply pipe, preventing wetting of the pipe and dripping onto the plants below.

Highly Uniform Watering

- Increases crop uniformity.

Highly Durable

- Made from the highest quality plastics with excellent Ultra-Violet (UV) resistance. Our reflective white tubing is completely opaque to prevent algae growth, UV resistant, and can withstand heat, direct sun and harsh chemicals.

Low Maintenance

- All sprinkler parts can be assembled and disassembled in the greenhouse without tools.



Design Help for Sprinkler & Fogger Systems

Step 1

Visualize the Greenhouse

Evaluate the location of obstacles such as curtains or hanging baskets. Consider aisles and whether they can be wetted. Review cultural practices which might impact the height at which the sprinklers should be placed.

Step 2a

Select a Sprinkler Head for Watering Applications (go to Step 2b for Misting, Propagation or Cooling Applications)

All sprinkler solutions are based on an average sprinkler working pressure of 30 psi and spacing between the sprinklers of three feet.

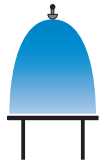

Single Bench with VibroNet Sprinklers

Bench Width (ft)	Spacing Between Sprinklers (ft)	Height Above Crop	
		2' - 3'	3' - 5'
4	3	VN-BL or VN-GN	VN-BL or VN-GN
5	3	VN-BL or VN-GN	VN-BL or VN-GN
6	3	VN-BL or VN-GN	VN-BL or VN-GN

For multiple benches or bays, use 7', 8' or 9' between lines.

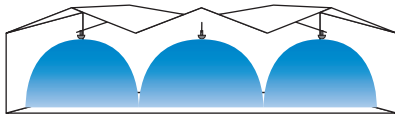

One Line for Single Bay or Quonset with SpinNet Sprinklers

Bay Width (ft)	Spacing Between Sprinklers (ft)	Height Above Crop		
		2' - 3'	4' - 5'	6' - 7'
10	3	R-R-BL	-	-
12	3	R-R-BL	R-R-BL	-
14	3	BR-BR-BL	BR-BR-BL	R-R-BL
15	3	R-R-GY	BR-BR-BL	R-R-BL
16	3	R-R-GY	BR-Y-GY	R-R-BL
18	3	R-R-GN	BR-Y-GY	BR-Y-GY
20	3	-	R-R-GN	BR-BR-GN
22	3	-	R-R-GN	BR-BR-GN
24	3	-	-	BR-BR-GN

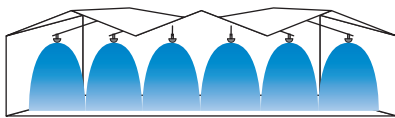
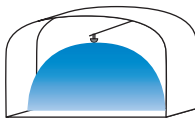

Two Line for Single Bay or Quonset with SpinNet Sprinklers

Bay Width (ft)	Spacing Between Sprinklers (ft)	Spacing Between Sprinkler Lines (ft)	Height Above Crop		
			3'	4' - 5'	6' - 7'
20	3	11	R-R-BL	-	-
22	3	12	R-R-BL	R-R-BL	-
24	3	12	R-R-BL	R-R-BL	R-R-BL
26	3	14	BR-BR-BL	R-R-BL	R-R-BL
28	3	15	BR-BR-BL	R-R-BL	R-R-BL
30	3	16	R-R-GY	R-R-GY	BR-BR-BL
32	3	17	R-R-GN	R-R-GY	BR-BR-BL
34	3	18	R-R-GN	R-R-GY	BR-BR-BL
36	3	19	R-R-GN	R-R-GY	R-R-GN
38	3	20	BR-BR-GN	R-R-GN	R-R-GN

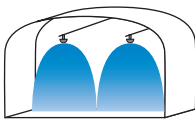

Ordering Guide

Code	Description	Model Number	Flow* (GPH)
VN-BL	VibroNet Blue Nozzle w/Check Valve	0354040L-B	9.2
VN-GN	VibroNet Green Nozzle w/Check Valve	0354050L-B	11.7
R-R-BL	SpinNet Red Mist Control, Red Body, Blue Spinner w/Check Valve	0355120070BL-B	18.4
BR-BR-BL	SpinNet Brown Mist Control, Brown Body, Blue Spinner w/Check Valve	0355160090BL-B	23.4
R-R-GY	SpinNet Red Mist Control, Red Body, Grey Spinner w/Check Valve	03551200070L-B	18.4
BR-Y-GY	SpinNet Brown Mist Control, Yellow Body, Grey Spinner w/Check Valve	03552000090L-B	23.4
R-R-GN	SpinNet Red Mist Control, Red Body, Green Spinner w/Check Valve	03551200070GL-B	18.4
BR-BR-GN	SpinNet Brown Mist Control, Brown Body, Green Spinner w/Check Valve	03551600090GL-B	23.4

*Average flow at 32 psi.

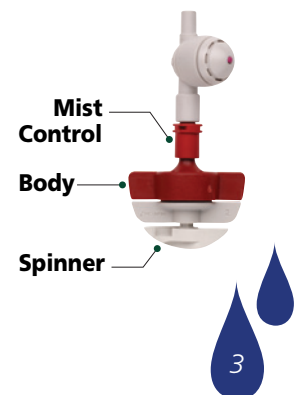

Step 2b

Select a Sprinkler Head for Misting, Propagating and Cooling Applications



VibroNet Sprinkler

For Misting Larger Areas

The VibroNet sprinkler with blue nozzle is used when a light mist is required for watering, for example when germinating seeds. Excellent uniformity can be achieved with sprinkler spacings between 3' and 5', with an elevation of 2' to 5'. The VibroNet sprinkler can be used upright or upside down.

Model Number	Description	Flow (GPH)
0354040L-B	Blue Nozzle with Check Valve	9.2



CoolNet Pro Fogger

The CoolNet Pro fogger is the best nozzle for propagation. It creates a zone of saturated humidity that is ideal for rooting. Average droplet size is 65 micron. Please see the back page for recommendations on how to use this product for propagation (humidifying) and cooling.

Model Number	Description	Flow (GPH)
0303420LL-B	4 Nozzles with Low Pressure Check Valve	8.1





Step 3

Select a Sprinkler Base

Netafim offers a selection of three bases to connect the sprinkler, mister or fogger to the supply pipe.

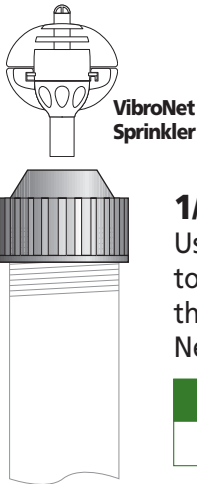

1/2" Adapter

VibroNet Sprinkler

1/2" Adapter

Used for connection to rigid pipe with 1/2" threaded connections and Netafim sprinklers.

Model Number

03206-B

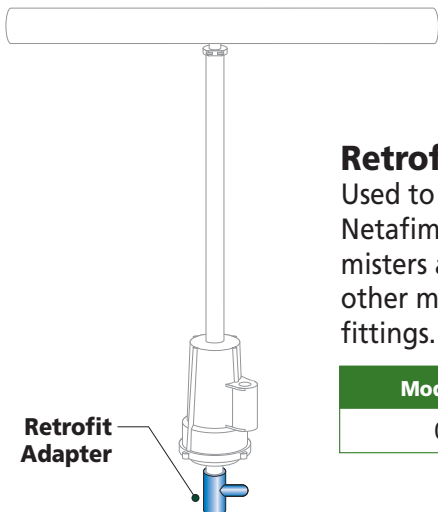

Retrofit Adapter

Retrofit Adapter

Used to connect Netafim sprinklers, misters and foggers to other manufacturer's fittings.

Model Number

03302-B

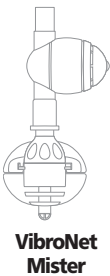

VibroNet Mister

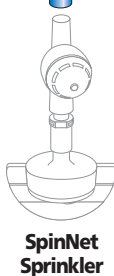

SpinNet Sprinkler

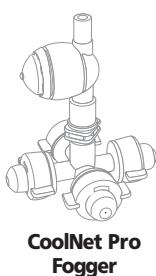

CoolNet Pro Fogger



Hanging Assembly

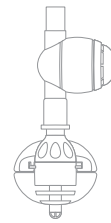

VibroNet Mister

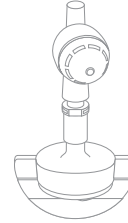

SpinNet Sprinkler

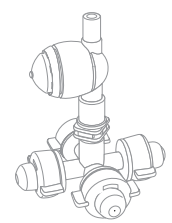

CoolNet Pro Fogger

Hanging Sprinkler, Mister or Fogger Assembly

Used for connection to Polyethylene (PE) Tubing with Netafim sprinklers, misters and foggers.

Model Number	Tube Length
0300HSAC-12-B	12"
0300HSAC-18-B	18"
0300HSAC-24-B	24"
0300HSAC-30-B	30"
0300HSAC-36-B	36"
0300HSAC-48-B	48"
0300HSAC-48X-B	Extension*

*Used to achieve tube lengths over 48".



Step 4

Size the Sprinkler Supply Pipe

Use the chart below to select the correct sprinkler supply size. Low density polyethylene is strongly recommended. Netafim also offers 3/4" or 1" polyethylene tubing with pre-punched holes at 36" spacings.



Netafim UV White™ PE Tubing
Offers a cool look, cooler water temperature, enhanced plant growth.

Poly Pipe Sizing

	Nozzle Color	Average Flow (GPH)	Length of Sprinkler Supply Pipe					
			25'	50'	75'	100'	125'	150'
CoolNet Pro Fogger	Grey	8.1	3/4"	3/4"	3/4"	3/4"	3/4"	3/4"
VibroNet Sprinkler	Blue	9.2	3/4"	3/4"	3/4"	3/4"	3/4"	3/4"
	Green	11.7	3/4"	3/4"	3/4"	3/4"	1"	1"
SpinNet Sprinkler (Body/Mist Control)	Red/Red	18.4	3/4"	3/4"	3/4"	1"	1"	1"
	Brown/Brown	23.4	3/4"	3/4"	3/4"	1"	1"	-
	Yellow/Brown	23.4	3/4"	3/4"	3/4"	1"	1"	-

Step 5

Size the Distributor and Mainline

The remaining piping and system components are sized based upon the maximum flow they will receive. Use the **Flow Per Sprinkler Line** chart to determine the flow of a single sprinkler supply pipe for the length of run in your design. If more than one sprinkler line will be operated at once, be sure to multiply the flow by the number of lines when sizing the system pipes and components. Pipe size recommendations are guidelines only. For distributor lines over 40 feet, mainlines over 100 feet or when slopes are a factor, please consult a design professional.

Flow Per Sprinkler Line (GPM)

	Nozzle Color	Average Flow (GPH)	Length of Sprinkler Supply Pipe (# of Sprinklers)					
			25' (9)	50' (17)	75' (25)	100' (34)	125' (42)	150' (50)
CoolNet Pro Fogger	Grey	8.1	1	2	3	4	6	7
VibroNet Sprinkler	Blue	9.2	1.5	2.5	4	5	6	7
	Green	11.7	2	3.5	5	6.5	8	10
SpinNet Sprinkler (Body/Mist Control)	Red/Red	18.4	3	5	8	10	13	15
	Brown/Brown	23.4	3	7	10	13	16	20
	Yellow/Brown	23.4	3	7	10	13	16	20

Distributor and Mainline Pipe Sizing

Pipe Size	Maximum GPM*
1/2"	6
3/4"	10
1"	17
1 1/4"	28
1 1/2"	37
2"	58

*Assumes class 160 PVC and 5 fps water velocity.

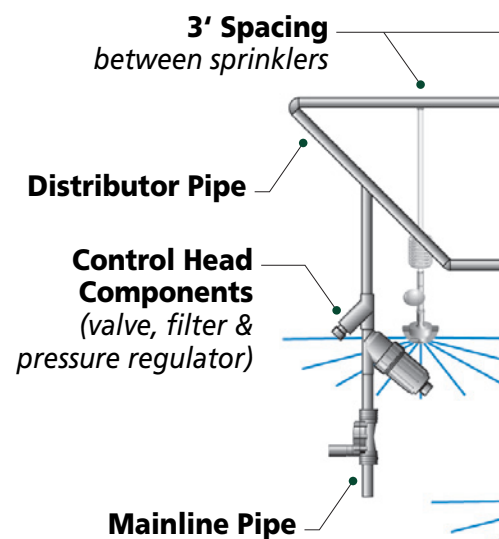



Step 6

Size the Head Control Components

The components should be sized according to the flow range shown in the **Filter, Valve & Pressure Regulator Sizing** chart. The pipe connecting to the components can be of a different size.

Filter and Valve Sizing

	Maximum Flow (GPM)	Unit Size	Model Number
Electric Valve (AC)	26	3/4" Globe	61ET.75GH2
	44	1" Globe	61ET1GH2
	110	1 1/2" Globe	61ET1.5GH2
	176	2" Globe	61ET2GH2
Disc Filter (120 mesh)	12	3/4"	25A45-120
	26	1"	25A47-120
	52	1 1/2" Super	25A17-120
	110	2" Dual Lite	25A2DL-120

Pressure Regulator Sizing

	Flow Range (GPM)	Unit Size	Model Number
Pressure Regulator (35 psi)*	5 to 17.6	3/4"	32PRV.75-35V2K
	11 to 35	1 1/2"	32PRV1.5-35V2K
	22 to 70	2" (x4)	32PRV2-435V2K

*A 35 psi regulator will typically provide the desired average sprinkler pressure after line and component pressure losses.

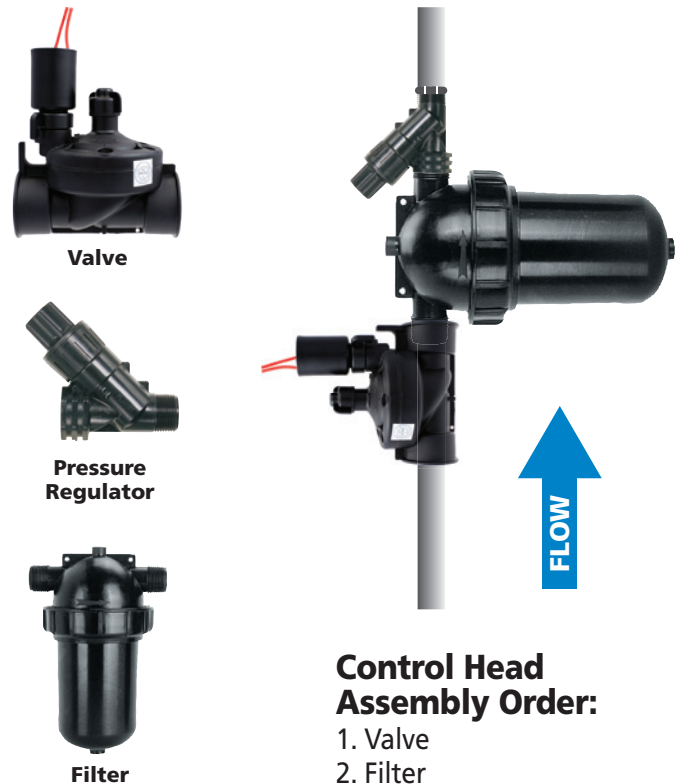

Control Head Assembly Order:

1. Valve
2. Filter
3. Pressure Regulator

*Size of components vary based on flow rate.

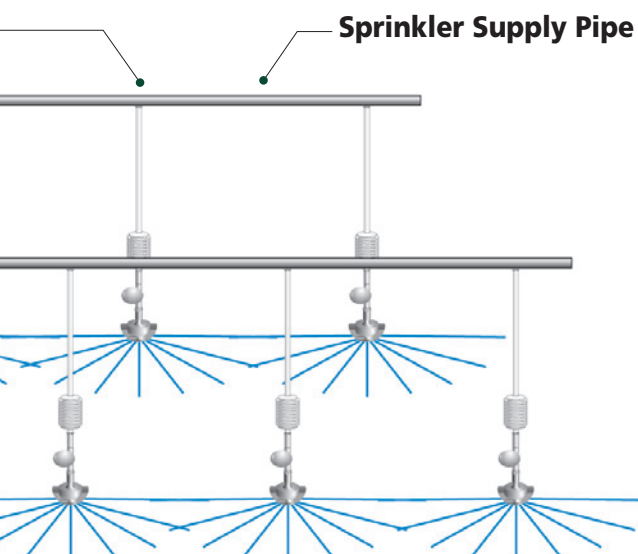

Step 7

Starting Up a System for the First Time

The most important point to remember when starting up a new system is to flush the mainlines. Debris from construction can otherwise be washed into the sprinklers, causing a plug or improper operation. To properly flush a system, first connect all the pipes and assemblies, except the sprinklers with Check Valves. Next, open the ends of the distributor line and the sprinkler supply pipes. Close them off, one by one, starting with the opening closest to the head control, and proceeding to the most distant opening. Only after complete flushing should the sprinklers with Check Valves be attached to the assemblies.



CoolNet Pro Fogger Installations

Rooting Benches (Propagation) Information

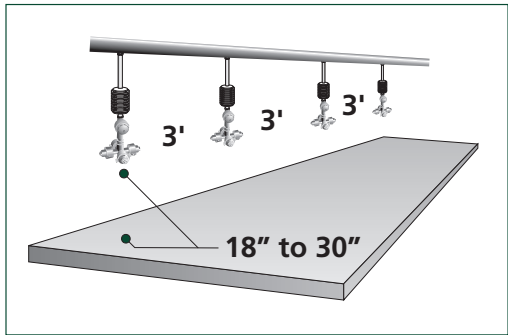

3 to 4 Foot Bench - The height of the fogger assembly should be 18" to 30" above the propagation material. The distance between the fogger assemblies should be 3 feet. *(Place the lateral above the center of a 3 to 4' bench.)*

Wide Bench - For wide benches (up to 8') use two lines of foggers equally distanced from the center of the bench. For large areas, use one row of foggers for every 4' width of area to be fogged.

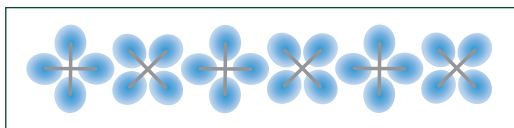

45° Offset - 4-way crosses should be placed at 45° angles to one another.

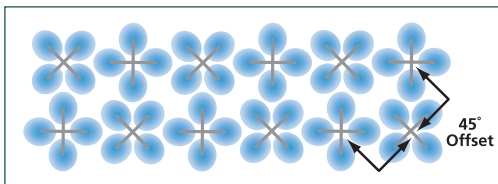

Humidification and Cooling Information

General Spacing and Operation for Humidifying and Cooling

Distance Between Fogger Units (ft.)	3	5	6.5	10	6.5	10
Distance Between Lines (ft.)	6.5	10.5	10	10	13	13
4-Way Fogger - Pulse (sec.)	1	3	5	10	20	30
4-Way Fogger - Interval (sec.)	74	91	120	150	355	345

- In order to maximize the cooling effect, exhaust fans are recommended to exchange the air about 20 times per hour.
- These recommendations are general and should be applied in accordance with local conditions and limitations.
- Duration of pulse and interval is to be fine-tuned according to local conditions; the timing provided is just a starting point.
- For crops that are not sensitive to wetting, the pulse can be prolonged, and/or the interval shortened.
- Other spacing can certainly be used with foggers; the spacings above give some reference points between spacing and operation intervals.

Typical Installation for Humidification or Cooling

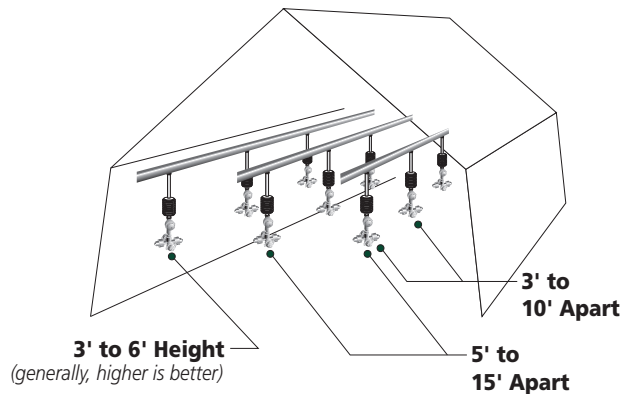

Cooling considerations include:

- Place foggers as high as possible
- Avoid spraying against the roof or structure
- Prevent precipitation by adjusting the cycle time



NETAFIM USA

5470 E. HOME AVE.

FRESNO, CA 93727

CS 888 638 2346

www.netafimusa.com

G221 2/14